



Atlas Air A7500

**Kit Number:
AA57589**

**Fits:
RAM Heavy Duty**

Engineered and Assembled in the USA

Installation Instructions

Before Getting Started

For optimal performance and safety, read all instructions thoroughly before beginning the installation. Failure to read and follow these instructions may lead to improper installation and potential safety risks.

Tools Needed

- Standard and metric open-end or box wrenches
- Ratchet
- Standard and metric, regular and deep-well sockets
- 5/16" Drill bit (very sharp)
- 9/16" Crows foot adapter (Fig. 1)
- Heavy-duty drill
- Torque wrench
- Standard and metric socket hex-key wrenches
- Hose cutter, razor blade or sharp knife
- Hoist or floor jacks
- Safety stands
- Safety glasses
- Air compressor or compressed air source
- Spray bottle with dish soap/water solution

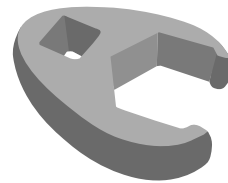

Crows foot
adapter

Fig. 1

AA57589 Exploded Installation View

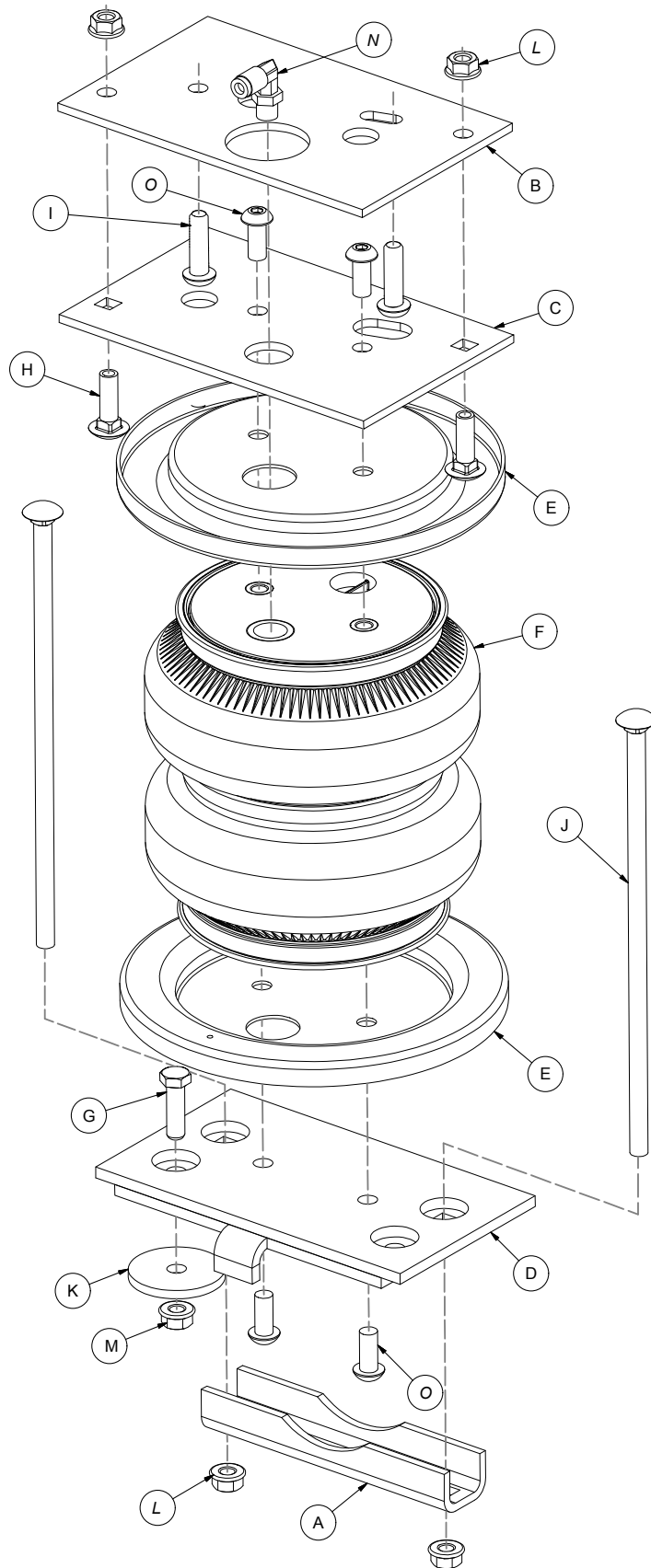

Driver's
(Left) Side

Fig. 2

Parts List

Part	Part No.	Part Description	QTY
A	01531GR	Clamp bar	2
B	07160GR	Upper frame bracket	2
C	07161GR	Upper air spring bracket	2
D	03038GR	Lower bracket	2
E	11897	Roll Plate	4
F	58126	Air Spring	2
G	17188	3/8"-16 x 1 1/4" Hex-head cap screw	2
H	17361	3/8"-16 x 1 1/4" Carriage bolt	4
I	17366	M10-1.50 x 35 Button-head cap screw	4
J	17387	3/8"-16 x 10" Carriage bolt	4
K	18260	Large flat washer	2
L	18422	3/8"-16 Serrated flange lock nut	8
M	18435	3/8"-16 Nylon lock nut	2
N	21837	Push-to-connect (PTC) swivel fitting	2
O	17527	3/8"-24 x 3/4" Button-head cap screw	8
AA	20086*	Air line	1
BB	10466*	Zip tie	6
CC	18411*	5/16" Lock washer	2
DD	21230*	Valve cap	2
EE	21233*	5/16"-32 Hex nut	4
FF	21234*	Rubber washer	2
GG	18501*	Flat washer	2

* These parts are not shown in the Exploded Installation View section

Introduction

This guide is here to walk you through setting up and taking care of your Atlas Air™ A7500 air suspension kit. They are built tough—commercial-grade and reinforced for durability. Think of the air springs like tires: layers of rubber and strong cords work together to manage pressure and maintain shape to help control your ride.

With Atlas Air A7500, you'll get up to 7500 pounds (3402 kg) of support to keep your ride level, and you can fine-tune the pressure anywhere between 5 and 100 PSI (0.34 to 7 BAR). Before diving into the installation or doing any kind of upkeep, make sure to read through the entire manual—it'll save you time and headaches down the road.

Symbols



THIS MEANS THERE'S AN IMMEDIATE AND SERIOUS RISK. IF IGNORED, IT WILL LEAD TO SEVERE INJURY OR EVEN DEATH. ALWAYS TAKE THESE WARNINGS SERIOUSLY.



SIGNALS A DANGEROUS SITUATION OR UNSAFE ACTION THAT COULD CAUSE SEVERE INJURY OR DEATH. IT'S NOT A GUARANTEE, BUT IT'S A BIG RISK—PROCEED CAREFULLY.



These callouts highlight useful advice or important reminders to keep you on track during the process. Don't skip them—they often save time.



Little tricks of the trade to help installation go more smoothly. These tips can make a big difference if you're aiming for a clean, efficient job.

Information

This kit does not increase the Gross Vehicle Weight Rating (GVWR) or payload capacity of your vehicle. Always refer to your vehicle's Safety Compliance Certification Label or owner's manual, and do not exceed the manufacturer's maximum load rating.

- **Gross Vehicle Weight Rating (GVWR):**

The maximum allowable weight of a fully loaded vehicle, including passengers, cargo, and fluids.

This value—along with other important specifications like tire size, rim size, and inflation pressure—is located on the vehicle's Safety Compliance Certification Label.

- **Payload:**

The maximum combined weight of passengers and cargo your vehicle is designed to carry. Payload is calculated by subtracting the vehicle's base curb weight from its GVWR.

Air Pressure Guidelines

While Atlas Air A7500 air springs are engineered to handle a **maximum inflation pressure of 100 PSI (7.0 BAR)**, the actual pressure required will vary based on the vehicle's load and total weight. Always adjust air pressure according to your specific load conditions—**not solely based on the maximum pressure limit.**

Ride Height and Suspension Limits

Always maintain the correct ride height by adjusting the air pressure based on your current load. Shock absorbers typically act as the suspension limiters on extension. If they do not, particularly on off-road vehicles, consider using limiting straps to prevent overextension.

Brake System Considerations

Vehicles equipped with a **rear brake proportioning valve** may experience changes in braking performance when using a load-assist product. **Consult your dealer** before installation. If your vehicle **does not** have a proportioning valve or is equipped with an **anti-lock brake system (ABS)**, the installation of an air spring kit **will not affect braking performance.**

Installation

Vehicle Preparation

1. Raise the vehicle, support the frame with safety stands and remove the wheels. Drop the axle to make room for the air spring assemblies to be put into position between the frame and axle (Fig. 3).

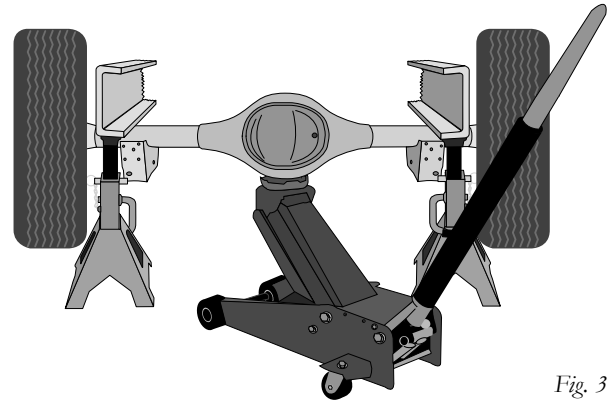

Fig. 3

2. On the driver's (left) side by the axle on some models, there is a small vent tube (Fig. 4) that needs to be tied on an angle with a zip tie (BB).

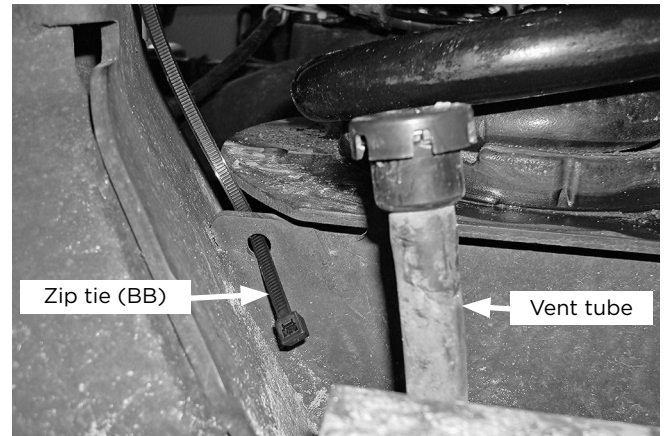

Fig. 4

3. Insert the zip tie into the small hole in the lower coil spring seat, then around the vent tube and snug the zip tie enough to angle the tube out of the way (Fig. 5).

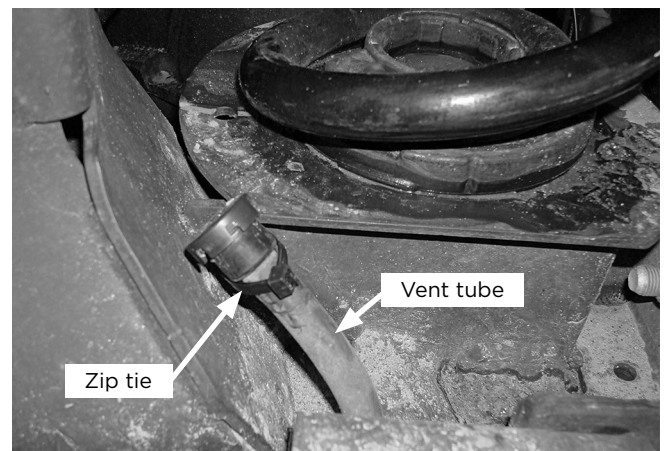

Fig. 5

- Remove the jounce bumpers from both sides (Figs. 6 & 7).

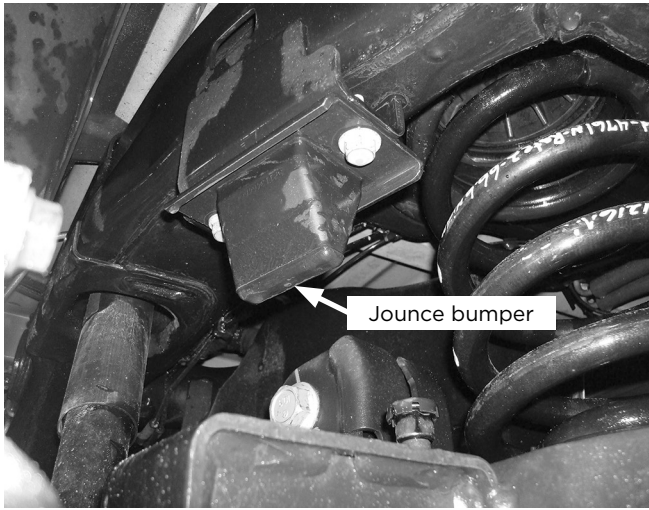

Fig. 6



Fig. 7

- Attach the upper frame bracket (B) to the frame (Figs. 8 & 9) using the M10-1.50 x 35 button-head cap screws (I). Torque the mounting hardware to 30 lb.-ft. (41Nm).



The large hole in the bracket goes to the outside of the frame (toward the tire).

DRIVER'S (LEFT) SIDE

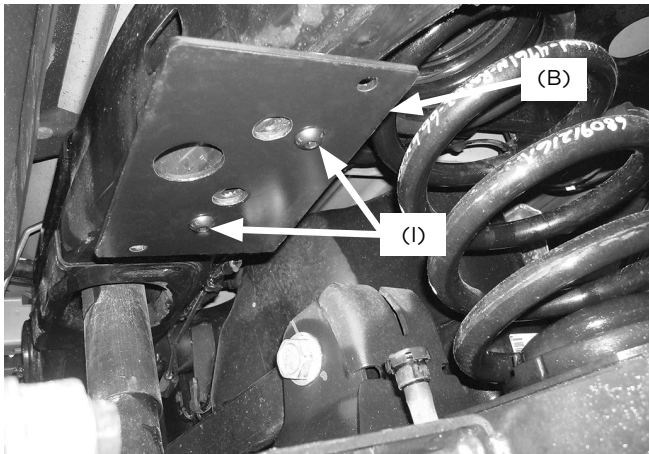

Fig. 8

PASSENGER'S (RIGHT) SIDE

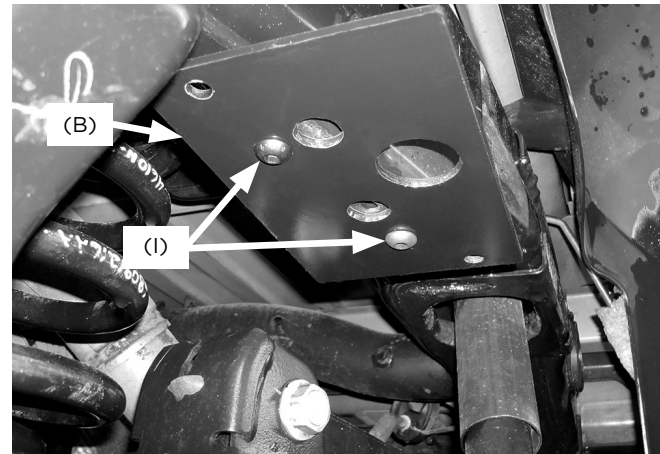

Fig. 9

Assemble the Air Spring Assemblies

1. Set a roll plate (E) over the top of each air spring (F) (Fig. 10).



The radiused (rounded) edge of the roll plate (E) will be toward the air spring so that the air spring is seated inside both roll plates.

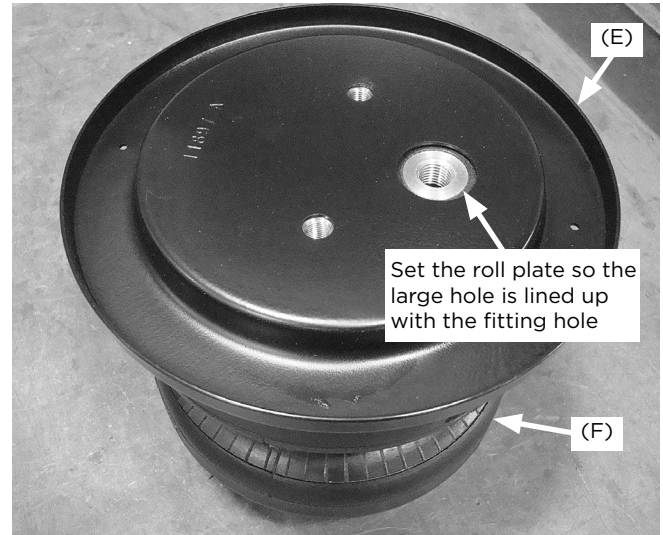

Fig. 10

2. Set both air springs in front of you with the fitting inserts pointing toward you (Fig. 11).
3. Insert the 3/8"-16 x 1 1/4" carriage bolt (H) through the upper air spring bracket (C) in the square hole on both ends (Figs. 2 & 11).



The upper air spring brackets will be mirror images when set onto the air springs (see Fig. 11).

**DRIVER'S
(LEFT) SIDE
ASSEMBLY**

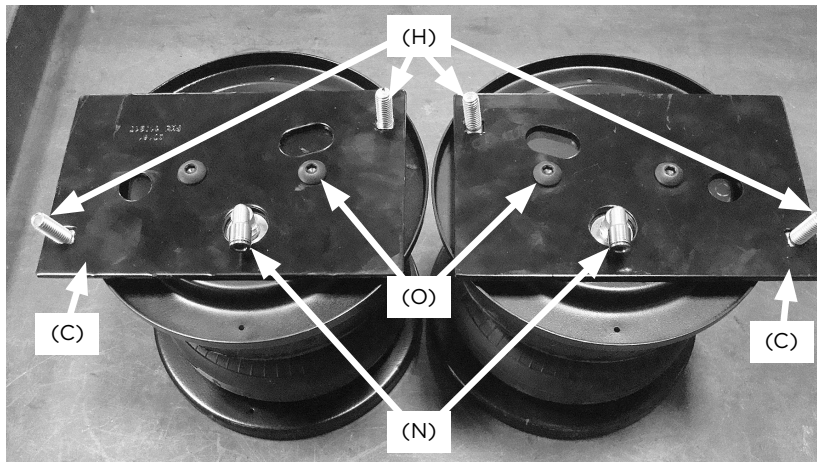

**PASSENGER'S
(RIGHT) SIDE
ASSEMBLY**

Fig. 11

4. Set both brackets onto the air springs and attach using the 3/8"-24 x 3/4" button-head cap screws (O) (Fig. 11). Torque to no more than 20 lb.-ft. (27Nm).
5. Install the swivel fitting (N) into the top of the air spring assemblies finger-tight plus 1 1/2 turns (Fig. 11). Repeat for both air springs.

- Install the thick 3/8" large flat washer (K) onto the lower bracket (D) with 3/8"-16 x 1 1/4" hex-head cap screw (G) and 3/8"-16 nylon lock nut (M). Install the washer on the same side as the flanges (Figs. 2 & 12). Torque to 31 lb.-ft. (42Nm).

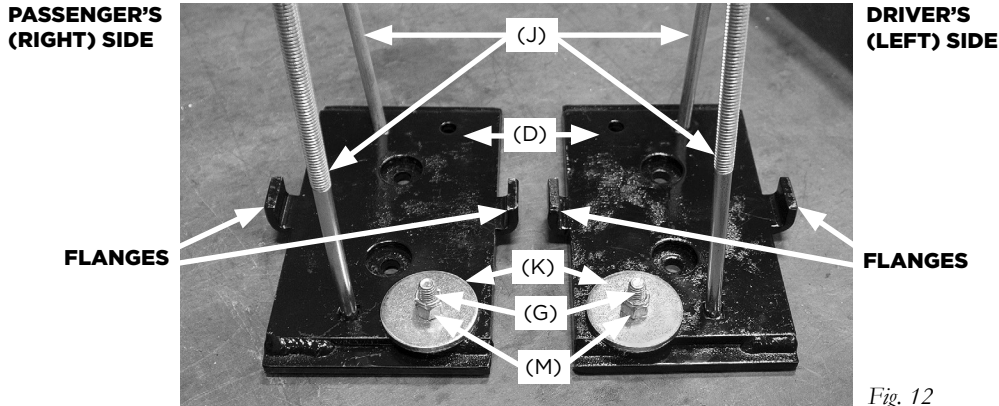
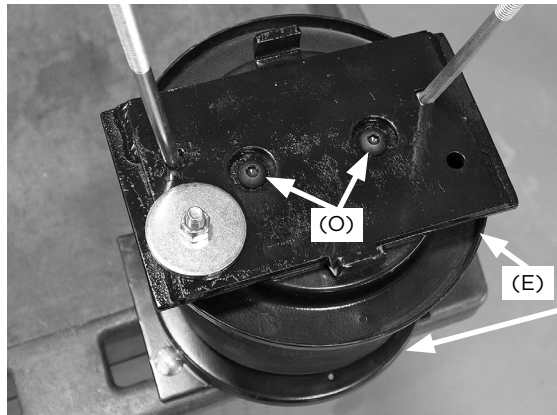

Fig. 12

- Insert the long 3/8"-16 x 10" carriage bolts (J) into the square holes in the lower bracket from the opposite sides of the flanges (Figs. 2 & 12).
- Set the roll plate (E) over the bottom of the air springs and install the lower brackets onto the air spring assemblies so the large washers previously installed are on the same side as the air fittings (Figs. 2 & 13).

PASSENGER'S (RIGHT) SIDE ASSEMBLY



The large washer needs to be positioned on the lower bracket so that it is on the same side of the assembly as the air fittings.

AIR FITTING

Fig. 13

- Once oriented correctly, attach the lower brackets to the assemblies using the 3/8"-24 x 3/4" button-head cap screws (O) (Fig. 13) and torque the hardware to no more than 20 lb.-ft. (27Nm).
- Figure 14 shows the finished assemblies.

PASSENGER'S (RIGHT) SIDE ASSEMBLY



DRIVER'S (LEFT) SIDE ASSEMBLY

Fig. 14

Install the Air Spring Assemblies

1. With the axle slightly hanging and the wheels removed, set the driver's (left) side assembly on the axle, making sure that the carriage bolt (J) goes in between the brake line and the axle, on the inboard side of the brake line bracket (Fig. 15). Repeat for the opposite side.

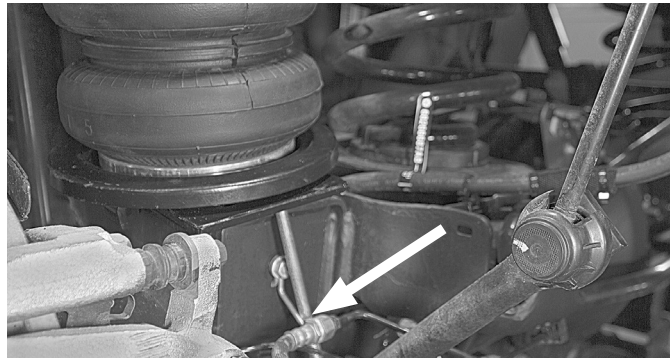

Carriage bolt must be in between the brake line and axle, on the inside of the brake line bracket on both driver's and passenger's air springs.

Fig. 15

2. Carefully position the upper air spring brackets, making sure that the carriage bolts and fittings line up with the holes in the frame brackets (Fig. 16). If necessary, raise the axle so that the brackets come together, making sure the fittings and the carriage bolts go through the holes and do not bind.

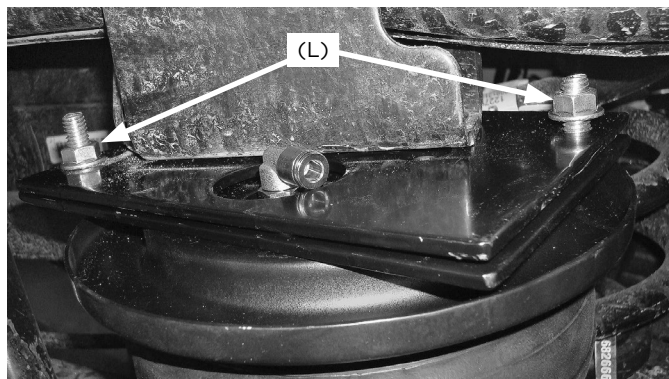

Fig. 16

3. Install the 3/8"-16 serrated flange lock nuts (L) onto the upper carriage bolts and torque to 16 lb.-ft. (22Nm) (Fig. 16).



It may be necessary to use a 9/16" crows foot adapter (Fig. 1) to torque the nut underneath the frame.

4. Raise the axle all the way and position the lower bracket over the lower jounce bumper strike plate. The large washer on the bottom of the bracket should be positioned forward of the lower jounce bumper strike plate (Fig. 17).

**DRIVER'S
(LEFT) SIDE
ASSEMBLY**

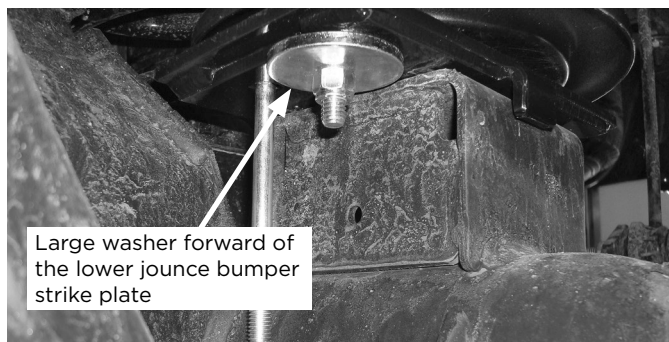

Large washer forward of the lower jounce bumper strike plate

Fig. 17

- Set the clamp bar (A) over the two long carriage bolts under the axle and fasten with 3/8"-16 serrated flange lock nuts (L) (Fig. 18). Torque the hardware evenly to 10 lb.-ft. (14Nm) (Fig. 19).

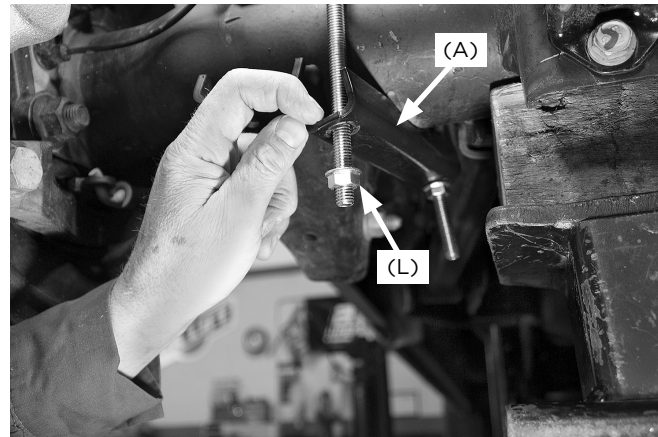

Fig. 18



Fig. 19

- Install the wheels and torque lug nuts to factory specifications. Remove the safety stands.



AFTER INSTALLING THE TIRES, IT WILL BE NECESSARY TO CHECK THE TIRE CLEARANCE. THERE MUST BE MORE THAN 1/2" (13MM) CLEARANCE BETWEEN THE TIRE AND THE UPPER ROLL PLATE ON THE AIR SPRING ASSEMBLY (FIG. 20). CHECK CLEARANCES IF CHANGING TIRE SIZES ON THE VEHICLES.

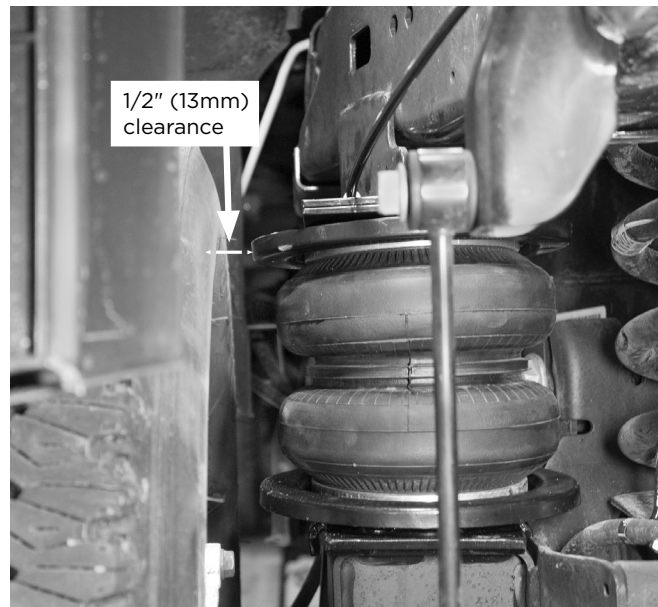

Fig. 20

Air Lines Installation

1. Select Schrader Valve Locations

Choose suitable locations for the Schrader valves. If necessary, drill a 5/16" (8 mm) hole at each selected location. Common locations for mounting are inside fuel tank filler door, inside rear wheel wells, or by the license plate mount or rear bumper area.

2. Measure and Cut the Air Line

Measure the length of air line needed to reach your intended Schrader valve locations. Cut the air line (AA) using a sharp razor blade or hose cutter to make clean, square cuts. Do not use scissors or wire cutters, as these can deform the tubing and compromise the seal.

3. Route and Secure the Air Line

Route the air line (AA) from each air spring to the chosen Schrader valve locations. Plan the route to avoid sharp edges, moving parts, and heat sources. Once routed, use zip ties (BB) to secure the air line to stable points along the vehicle chassis. Do not pinch or kink the line. Leave at least 2" (51 mm) of slack to accommodate movement. The air line's minimum bend radius is 1" (25 mm).



Maintain a minimum of 5 1/2" (140 mm) clearance between all air lines and any part of the exhaust system. Avoid routing air lines over sharp edges or making tight bends.

4. Install Schrader Valves

Install the Schrader valves into the selected locations.

Heat Shield Installation (if provided in kit)

1. Position the Heat Shield

Place the heat shield over the exhaust pipe near the air spring. Maintain at least 1/2" (13 mm) of clearance between the shield and the exhaust surface. Depending on the design of the heat shield included in your kit, you may need to bend the tabs or the shield itself to achieve proper fitment and spacing.

2. Install the Air Line Thermal Sleeve (if included)

If your kit includes a thermal sleeve, slide it over the section of air line that runs closest to the exhaust. This sleeve helps protect the line from excessive heat exposure.

3. Secure Components with Hose Clamps

Use hose clamps to secure the heat shield and thermal sleeve (if used). Apply double clamps where needed for added security. Make final adjustments to ensure all components are properly spaced and firmly in place.

Checklist

Ensure the air suspension system is correctly installed and safe for operation by completing the following checks:

1. Clearance Verification

Inflate the air springs to 50 PSI (3.45 BAR). Confirm a minimum clearance of 1/2" (13 mm) between the air springs and any adjacent components, including tires, brake assemblies, the vehicle frame, shock absorbers, and brake lines. Adjust as needed to prevent contact during operation.

2. Heat Clearance Check

Verify that all air springs and air lines are positioned at least 5 1/2" (140 mm) away from any heat sources.

3. Leak Inspection

With the system pressurized to 50 PSI (3.45 BAR) inspect all fittings, air lines, and connections for leaks. All leaks must be fully resolved prior to road testing.

4. Road Test Procedure

Inflate the air springs to the recommended operating pressure and conduct a 10-mile (16 km) road test. Upon completion, re-inspect for adequate clearance, air leaks, and secure fasteners.

5. Torque Confirmation

After 500 miles (800 km) of driving, recheck and torque all hardware to the specified values to ensure long-term stability and safety.

Adjusting Air Pressure

Stability

Properly adjusting air pressure is key to achieving both vehicle stability and correct ride height. Begin by increasing pressure until the suspension feels firm and controlled—without exceeding the maximum of 100 PSI (7 BAR). Ensure the vehicle sits level across all four corners. Uneven loads may require redistributing cargo or adjusting air pressure side to side.

Comfort

Ride quality is also influenced by air pressure. Too much or too little can cause harshness or instability. As a general rule:

- If the vehicle frequently bottoms out on the frame, increase air pressure.
- If the ride feels overly stiff or harsh, reduce air pressure slightly.

Adjust gradually to find the best balance between comfort and control.

Guidelines

1. Check System Pressure Weekly

Inspect the air pressure in the system at least once a week to ensure consistent performance and ride quality.

2. Maintain Proper Ride Height

Always operate the vehicle at the recommended ride height. Do not exceed 100 PSI (7.0 BAR) under any circumstances.

3. Inspect for Air Leaks as Needed

If you suspect a leak, follow these steps to identify and address the issue:

- Inflate the air springs to 50 PSI (3.45 BAR).
- Spray all air line connections and the inflation valve with a mild solution of liquid dish soap and water.
- Wait 30 seconds and observe for any bubbles, which indicate a leak.
- Recheck the system pressure after 24 hours. A pressure loss of 2–4 PSI (0.14–0.28 BAR) is normal after initial installation. If the pressure drops by more than 5 PSI (0.34 BAR), recheck for leaks.
- Once testing is complete, adjust the air spring to the minimum pressure required for proper ride height.

4. Inspect Hardware and Component Alignment

Periodically check that all fasteners are properly torqued. Also, check for signs of rubbing or misalignment, and realign components as needed.

5. Clean the Air Springs

Occasionally, spray the air springs with clean water to remove mud, dirt, or debris that may collect during use.

6. Lift the Vehicle with Care

If lifting the vehicle by the frame, reduce system pressure to 5 PSI (0.34 BAR) to relieve tension on the air springs and mounting hardware.

Repair Guide

Fixing Leaks on Barbed Fittings

1. Cut the air line 1 1/2" (38 mm) behind the existing fitting.
2. Use pliers or locking pliers to twist and pull the air line off the fitting.



Do not cut lengthwise, as this may damage the barbs and lead to future leaks.

3. Reinstall the air line and clamp (if applicable), making sure the air line fully covers all barbs for a proper seal.

Fixing Leaks on Push-to-Connect (PTC) Fittings

To Disconnect:

1. Release all air pressure from the system.
2. Push the air line inward toward the fitting.
3. While holding the air line in, press the collar inward toward the fitting.
4. With the collar depressed, pull the air line out.

Before Reconnecting:

5. Cut off the end of the air line just beyond the witness mark to ensure a clean, undamaged sealing surface.
6. If the fitting leaks at the threads, remove it, apply fresh thread sealant, and reinstall it 1 1/2 turns beyond finger-tight.

To Reconnect:

7. Push the air line into the fitting until fully seated.
8. Gently pull back on the air line to verify a secure connection.

Warranty

What this warranty covers

Atlas Products Company provides a warranty to the original purchaser of its Load Support Products, for the periods of time listed at AtlasProducts.com, by product line, from the date of original purchase, that the products will be free from defects in workmanship and materials when used on cars and trucks as specified by Atlas Products Company and under normal operating conditions, subject to the requirements and exclusions set forth below.

What this warranty does not cover

The warranty does not apply to products that have been improperly applied, improperly installed, or that have not been maintained in accordance with the installation instructions furnished with all products. This warranty does not apply and is void if damage or failure is caused by: accident, abuse, misuse (including but not limited to racing or off-road activities or commercial use), abnormal use, faulty installation, liquid contact, fire, earthquake or other external cause; operating the product outside Atlas Products Company's instructions, specifications or guidelines; or service, alteration, maintenance or repairs performed by anyone other than Atlas Products Company to the product from its purchased condition. This warranty also does not apply to: consumable parts, such as batteries, cosmetic damage, including but not limited to scratches or dents; defects caused by normal wear and tear or otherwise due to the normal aging of the product, or if any serial or identification number has been removed or defaced from the product. Atlas Products Company reserves the right to change the design of any product without assuming any obligation to modify any product previously manufactured.

Limitation of liability

To the extent permitted by law, this warranty and the remedies set forth herein are exclusive and in lieu of all other warranties, remedies and conditions, whether oral, written, statutory, express or implied. Atlas Products Company DISCLAIMS ALL STATUTORY AND IMPLIED WARRANTIES, INCLUDING WITHOUT LIMITATION, WARRANTIES OF MERCHANTABILITY AND FITNESS FOR A PARTICULAR PURPOSE AND WARRANTIES AGAINST HIDDEN OR LATENT DEFECTS TO THE EXTENT PERMITTED BY LAW. To the extent such warranties cannot be disclaimed, such implied warranties shall apply only for the warranty period specified above. Please note that some states do not allow limitation on how long an implied warranty (or condition) lasts. So the above limitation may not apply to you.

Except as provided in this warranty and to the extent permitted by law, Atlas Products Company shall not be liable for any direct, special, incidental or consequential damages resulting from any breach of warranty or condition, or arising in connection with the sale, use or repair of Atlas products, or under any other legal theory, including but not limited to loss of use, loss of revenue, loss of actual or anticipated profits, loss of the use of money, loss of business, loss of opportunity, loss of goodwill, and loss of reputation. Atlas Products Company's maximum liability shall not in any case exceed the purchase price paid by you for the Atlas product. Please note that some states do not allow the exclusion or limitation of incidental or consequential damages, so the above limitation or exclusion may not apply to you.

How to get service

If a defect in workmanship or materials causes your Atlas product to become inoperable within the warranty period, before returning any defective product, email Atlas Products Company at support@atlusproducts.com. The consumer shall be responsible for removing the defective product from the vehicle (including any labor charges) and returning it, shipping costs prepaid, to Atlas Products Company for verification. You must prove to the satisfaction of Atlas Products Company the date of original purchase of your Atlas product. A minimum \$10 shipping and handling charge (plus applicable sales tax) will apply to all warranty claims. You must also pack the product to minimize the risk of it being damaged in transit. If we receive a product in damaged condition as the result of shipping, we will notify you and you must seek a claim with the shipper.

What Atlas Products Company will do

If you submit a valid claim to Atlas Products Company during the warranty period, and Atlas determines that the product was defective, Atlas Products Company will, at its option, repair your Atlas product or furnish you with a new or rebuilt product. Atlas Products Company will not reimburse you for repairs or replacement parts provided by other parties. Your repaired or replacement Atlas product will be returned to you (subject to payment of the required warranty claim shipping and handling charge), and it will be covered under the warranty for the balance of the warranty period, if any. When a product or part is replaced, any replacement item becomes your property and the replaced item becomes the property of Atlas Products Company. You are responsible for the installation/reinstallation (including any labor charges) of the product.

How the law relates to this warranty

This warranty gives you specific legal rights and you may also have other rights which vary from state to state. By this warranty, Atlas Products Company does not limit or exclude your rights except as allowed by law. To fully understand your rights, you should consult the laws of your state.

Customer Support

For Customer Service support, please contact us at:
support@atlusproducts.com

Atlas Products Company reserves the right to make changes and improvements to its products and publications at any time.



Engineered and Assembled in the USA

Document No. AM-2008
Revision (012601)
ERN 10575

California:  WARNING: Cancer and Reproductive Harm - www.P65Warnings.ca.gov