



Atlas Air A7500

**Kit Number:
AA57552**

**Fits:
Ford SD F-250/F-350 4WD
SRW (Single Rear Wheel)**

Engineered and Assembled in the USA

Installation Instructions

Before Getting Started

For optimal performance and safety, read all instructions thoroughly before beginning the installation. Failure to read and follow these instructions may lead to improper installation and potential safety risks.

Tools Needed

- Metric & standard open-end box wrenches
- Ratchet with metric and standard sockets
- Drill and 5/16" drill bit
- Torque wrench
- Hex key wrenches metric and standard
- 9/16" Crows foot adapter
- 9/16" Ratchet combo wrench
- Mid-size adjustable wrench
- Hose cutter, razor blade or sharp knife
- Hoist or floor jack
- Safety stands
- Safety glasses
- Air compressor or compressed air source
- Spray bottle with dish soap/water solution

AA57552 Exploded Installation View

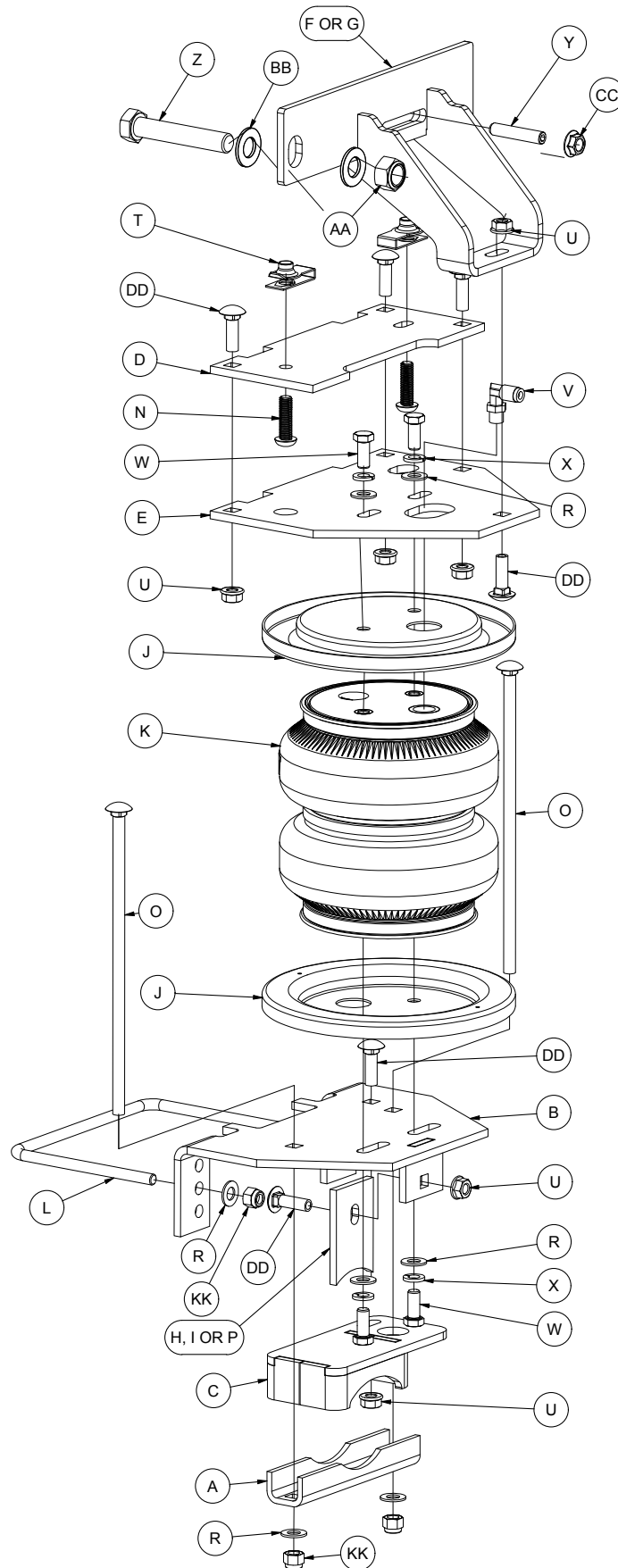

Driver's (Left) Side

Parts List

Part	Part No.	Part Description	QTY
A	01531GR	Clamp bar	2
B	03069GR	Lower bracket	2
C	03224GR	Lower bracket, cup	2
D	07974GR	Upper frame bracket	2
E	07925GR	Upper air spring bracket	2
F	07895GR	RH upper frame brace	1
G	07645GR	LH upper frame brace	1
H	03911GR	Lower leg adapter, Tremor	2
I	11688GR	Lower leg adapter, 3.5" axle	2
J	11897	Roll plate	4
K	58126	Air spring	2
L	11770	U-bolt	2
N	17366	M10-1.5 x 35mm Button-head cap screw	4
O	17387	3/8"-16 x 10" Carriage bolt	4
P	11690GR	Lower leg adapter, 4" axle	2
R	18444	3/8" Flat washer	16
S*	18501	M8 Flat washer	2
T	18622	M10-1.5mm, Short universal nut	4
U	18422	3/8"-16 Serrated flange lock nut	10
V	21837	1/8" NPT x 1/4" PTC swivel 90 degree fitting	2
W	17203	3/8"-24 x 7/8" Hex bolt	8
X	18427	3/8" Lock washer	8
Y	17525	M10 x 1.5 x 50mm Set screw	1
Z	17348	5/8"-11 x 4 1/2" Hex cap screw	3
AA	18548	5/8"-11 Nylon lock nut	3
BB	18449	5/8"-11 Flat washer	6
CC	18651	M10 x 1.5 Serrated flange lock nut	1
DD	17134	3/8"-16 x 1" Carriage bolt	12
EE*	10466	Zip ties	6
FF*	21230	Valve cap	2
GG*	21234	Rubber washer	2
HH*	18411	Small star washer	2
II*	21233	5/16" Hex nut	4
JJ*	20086	Air line assembly	1
KK	18435	3/8"-16 Nylon lock nut	8

* These parts are not shown in the Exploded Installation View section

Introduction

This guide is here to walk you through setting up and taking care of your Atlas Air™ A7500 air suspension kit. They are built tough—commercial-grade and reinforced for durability. Think of the air springs like tires: layers of rubber and strong cords work together to manage pressure and maintain shape to help control your ride.

With Atlas Air A7500, you'll get up to 7500 pounds (3402 kg) of support to keep your ride level, and you can fine-tune the pressure anywhere between 5 and 100 PSI (0.34 to 7 BAR). Before diving into the installation or doing any kind of upkeep, make sure to read through the entire manual—it'll save you time and headaches down the road.

Symbols



THIS MEANS THERE'S AN IMMEDIATE AND SERIOUS RISK. IF IGNORED, IT WILL LEAD TO SEVERE INJURY OR EVEN DEATH. ALWAYS TAKE THESE WARNINGS SERIOUSLY.



SIGNALS A DANGEROUS SITUATION OR UNSAFE ACTION THAT COULD CAUSE SEVERE INJURY OR DEATH. IT'S NOT A GUARANTEE, BUT IT'S A BIG RISK—PROCEED CAREFULLY.



These callouts highlight useful advice or important reminders to keep you on track during the process. Don't skip them—they often save time.



Little tricks of the trade to help installation go more smoothly. These tips can make a big difference if you're aiming for a clean, efficient job.

Information

This kit does not increase the Gross Vehicle Weight Rating (GVWR) or payload capacity of your vehicle. Always refer to your vehicle's Safety Compliance Certification Label or owner's manual, and do not exceed the manufacturer's maximum load rating.

- **Gross Vehicle Weight Rating (GVWR):**

The maximum allowable weight of a fully loaded vehicle, including passengers, cargo, and fluids.

This value—along with other important specifications like tire size, rim size, and inflation pressure—is located on the vehicle's Safety Compliance Certification Label.

- **Payload:**

The maximum combined weight of passengers and cargo your vehicle is designed to carry. Payload is calculated by subtracting the vehicle's base curb weight from its GVWR.

Air Pressure Guidelines

While Atlas Air A7500 air springs are engineered to handle a **maximum inflation pressure of 100 PSI (7.0 BAR)**, the actual pressure required will vary based on the vehicle's load and total weight. Always adjust air pressure according to your specific load conditions—**not solely based on the maximum pressure limit.**

Ride Height and Suspension Limits

Always maintain the correct ride height by adjusting the air pressure based on your current load. Shock absorbers typically act as the suspension limiters on extension. If they do not, particularly on off-road vehicles, consider using limiting straps to prevent overextension.

Brake System Considerations

Vehicles equipped with a **rear brake proportioning valve** may experience changes in braking performance when using a load-assist product. **Consult your dealer** before installation. If your vehicle **does not** have a proportioning valve or is equipped with an **anti-lock brake system (ABS)**, the installation of an air spring kit **will not affect braking performance.**

Installation

Vehicle Preparation

1. Raise the vehicle and support it in a way, using safety stands or equivalent, that the axle can be safely lowered away from the frame. This will need to be done in order for the air spring assembly to be put into position between the axle and frame (Fig. 1).

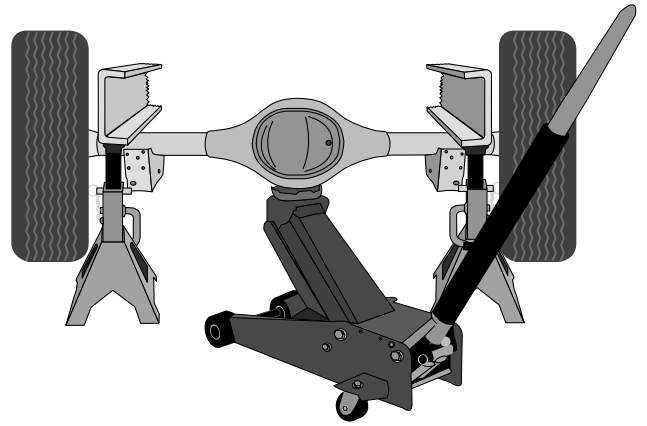

Fig. 1

Install the Upper Frame Brackets

1. Unbolt and remove the jounce bumper assembly from under the frame on both sides (Fig. 2).



Fig. 2

2. Remove the clip-in studs by prying on the hinged end with a screwdriver to release. Pull all four clip-in studs out of the frame (Fig. 3).

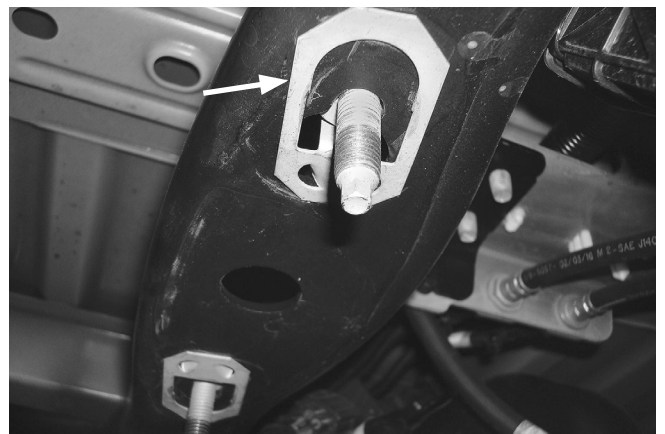

Fig. 3

3. Install the universal nuts (T) into the frame rail, lining up the holes in the frame and the threads in the nuts so that a bolt can be installed (Fig. 4).



A flat-tipped screwdriver works well for installing the universal nut into position.

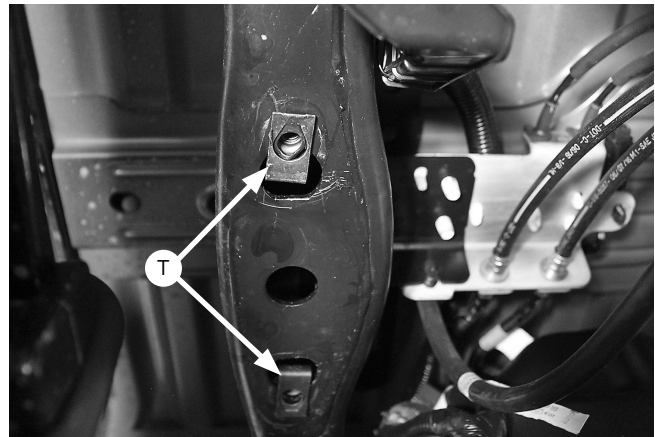

Fig. 4

4. Insert the 3/8"-16 x 1" carriage bolts (DD) into the upper frame bracket (D). Install the upper frame bracket onto the frame using the M10-1.5 x 35mm button-head cap screws (N) so that the large cut-out on the side of the bracket is inboard of the frame rail and the slotted hole in the center is forward (Fig. 5). Torque hardware to 38 lb.-ft. (52Nm).

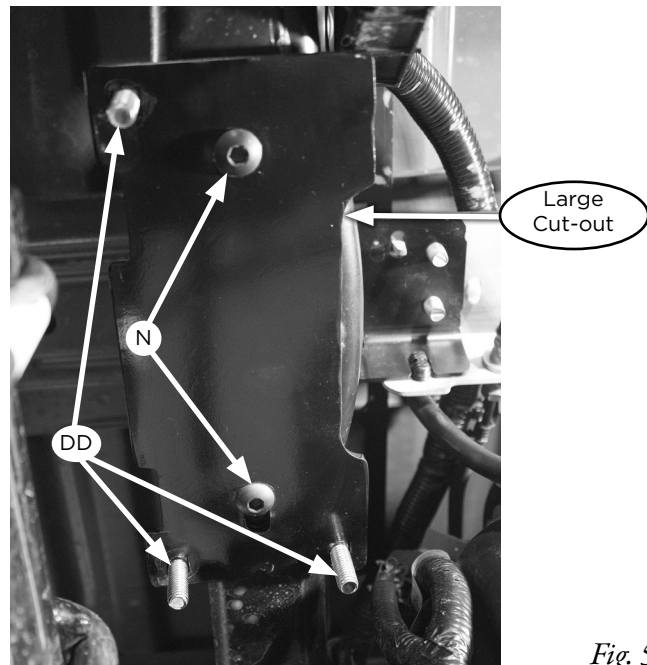

Fig. 5

Air Spring and Bracket Assembly

1. Install the swivel elbow fitting (V) into the top of the air spring finger-tight. Tighten the swivel fitting an additional one and a half turns. Place a roll plate (J) on top of the air spring (Fig. 6).

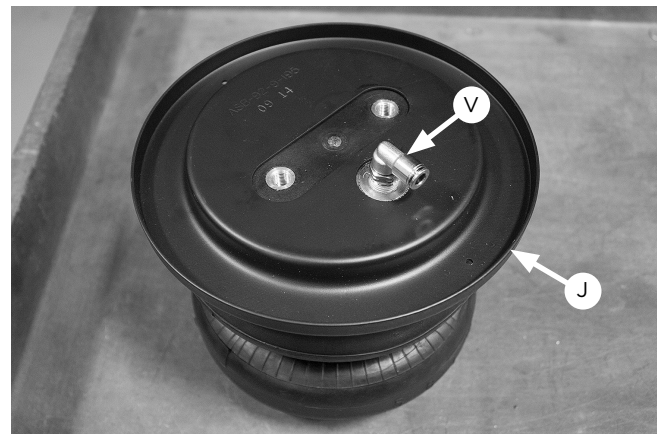

Fig. 6

2. Insert 3/8"-16 x 1" carriage bolts (DD) into the square holes on the brackets, then secure the upper air spring bracket (E) onto the top of the air springs using 3/8"-24 x 7/8" hex bolts (W), 3/8" lock washers (X) and 3/8" flat washers (R). At this stage, the air spring assemblies are left- and right-hand units. Push the brackets as far forward as possible (Fig. 7). Torque the hardware to no more than 20 lb.-ft. (27Nm).

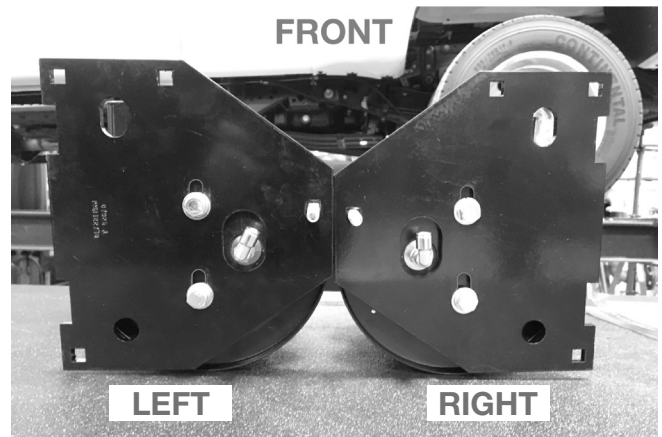

Fig. 7

3. Flip the assemblies over and set a roll plate (J) onto the bottom of the air spring (Fig. 8).



Fig. 8

4. Insert a 3/8"-16 X 1" carriage bolt (DD) through the top of the lower bracket (B) as shown in Fig. 9. Flip the assembly over and set the lower bracket cup (C) onto the lower bracket and over the carriage bolt (Fig. 10). Cap with 3/8"-16 serrated flange lock nut (U) and snug the nut only. Leave loose enough for the bracket to move freely in the slot.

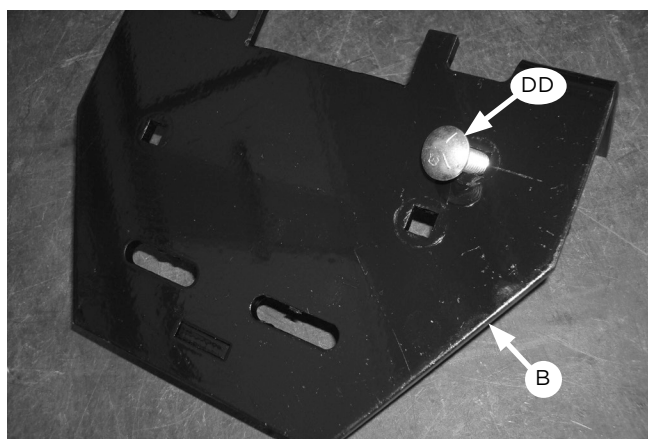

Fig. 9

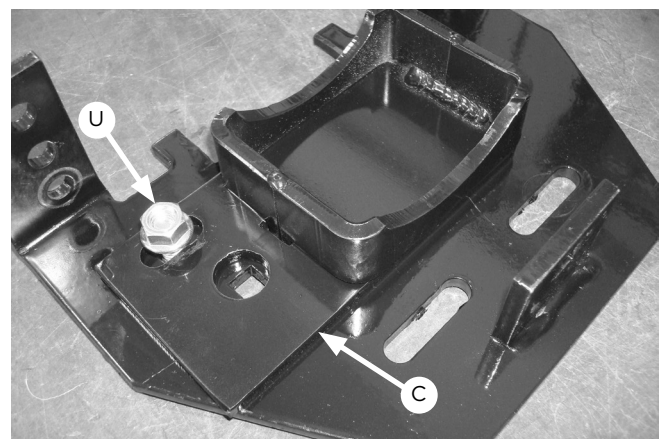

Fig. 10

5. Insert two 3/8"-16 x 10" carriage bolts (O) through the remaining square holes in the lower bracket (B) (Fig. 11).

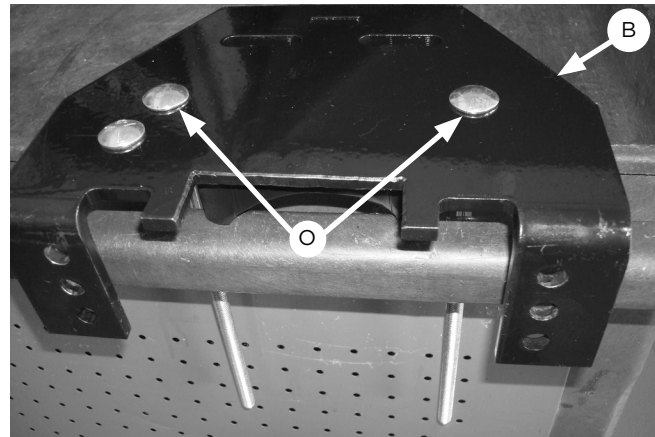

Fig. 11

6. Set the lower bracket assemblies onto the air springs with a roll plate installed and attach with two 3/8"-24 x 7/8" hex bolts (W), 3/8" lock washers (X) and 3/8" flat washers (R) (Fig. 12). Push the lower bracket as far forward as possible. Refer to Fig. 13. Torque the hardware to no more than 20 lb.-ft. (27Nm).



Fig. 12

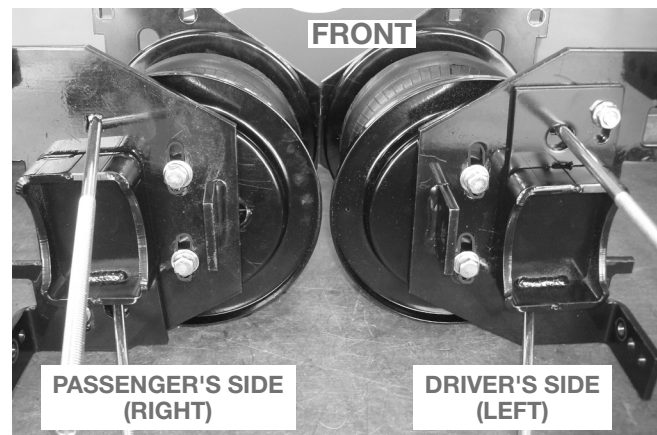

Fig. 13

- Select the appropriate leg adapter for the specific vehicle as noted in the chart. Use Tremor adapter (H) for Tremor models. For non-Tremor models, use the 3.5" (I) or 4" (P) adapter depending on what the vehicle has for the axle diameter. Attach the appropriate adapter with a 3/8"-16 x 1" carriage bolt (DD) and 3/8" serrated flange lock nut (U) (Fig. 14). Install as shown (Fig. 15). Push adapter against the lower bracket and torque the hardware to 16 lb.-ft. (14Nm).

Application	Adapter Part #
3.5" Axle	11688 (I)
4" Axle	11690 (P)
Tremor	03911 (H)

Table 1

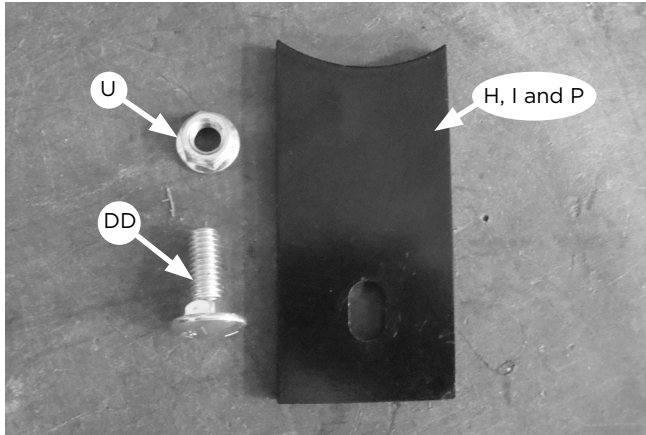

Fig. 14

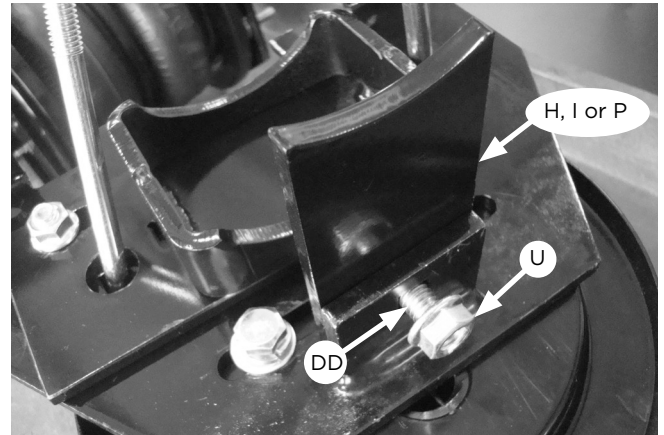

Fig. 15

- Refer to Fig. 16 for the driver's (left) and passenger's (right) side assemblies.

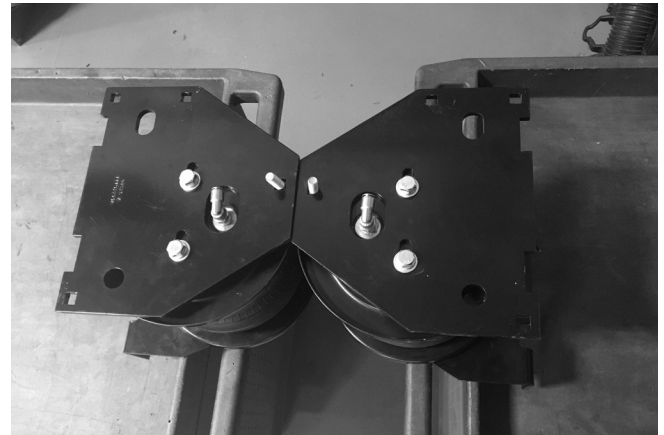

Fig. 16

Prepare the Vehicle

1. To make room for the lower bracket leg it will be necessary to move the ABS line that is attached to the brake line/ABS bracket mounted on the axle. To do this, first remove the tree mount from the bottom, left side of the bracket (Fig. 17).



Fig. 17

2. Zip tie the ABS line to the hard brake line (red circle) to keep it away from the lower support leg (Fig. 18).

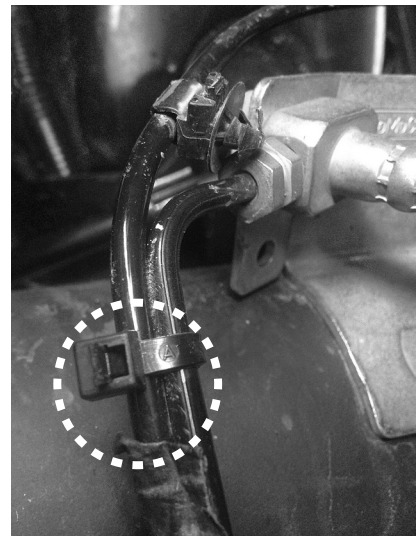

Fig. 18

Install the Braces

1. To install the driver's (left) side upper brace (G), if equipped, remove the rearward fifth wheel bracket hardware, set aside for later use (Fig. 19).



Fig. 19

2. Locate the two M10 bolts holding the brake line bracket to the frame (Fig. 20). Unbolt both and pull the bracket away from the frame (Fig. 21).

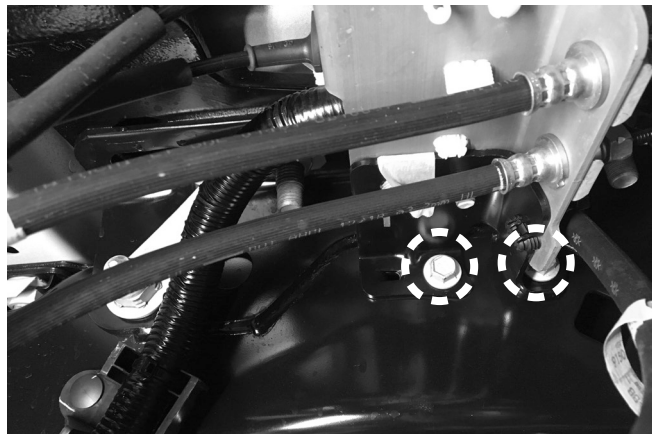

Fig. 20



Fig. 21

3. Install the 50mm set screw (Y) into the rearward threaded hole. Leave about 30mm (1.20") protruding from the frame (Fig. 22).

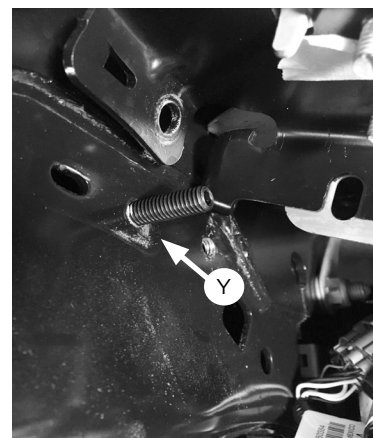

Fig. 22

4. Set the upper brace (G) in place over the 50mm set screw (Y) and against the frame. Ensure the hole in the rear of the brace lines up with the fifth wheel bracket hole in the frame. Set the stock brake line bracket, previously removed, over the 50mm set screw and on top of the brace. Thread the M10 serrated flange lock nut (CC) onto the set screw. Reinstall the factory fifth wheel hardware previously removed (if equipped) or use the supplied 5/8" (Z, AA, BB) hardware through the frame and brace (Fig. 23 & Fig. 24). Leave loose at this time.

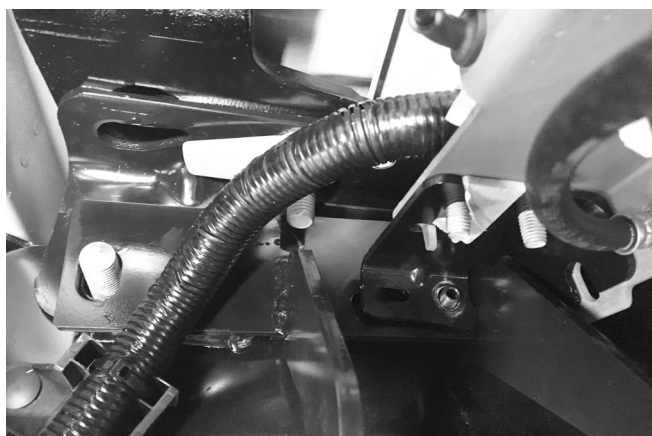

Fig. 23

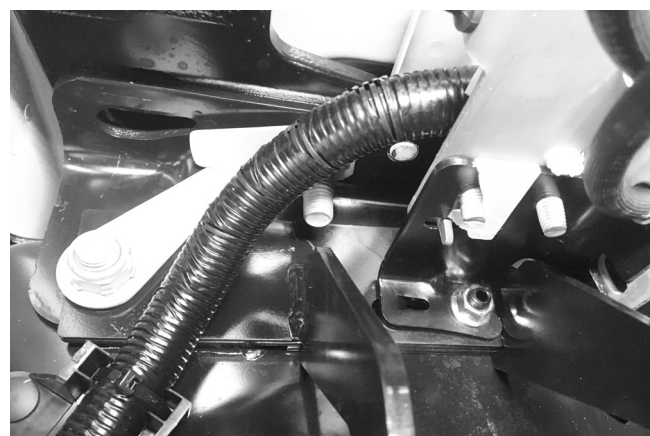

Fig. 24

- To install the passenger's (right) side upper brace (F) locate the clip (red circle Fig. 25) that holds the wiring harness for the O2 sensor. Remove and discard the clip as it will no longer be needed.



Some models may not have the O2 sensor clip.

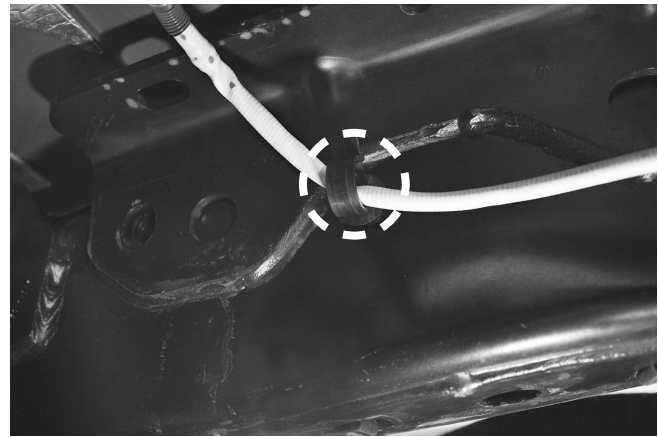

Fig. 25

- Remove the factory fifth wheel hitch hardware (if equipped), from the holes in the side of the frame. Using the existing holes in the frame, attach the upper frame brace (F) to the frame using the factory hitch hardware removed or the 5/8" (Z, AA, BB) hardware supplied (Fig. 26). Leave loose at this time.

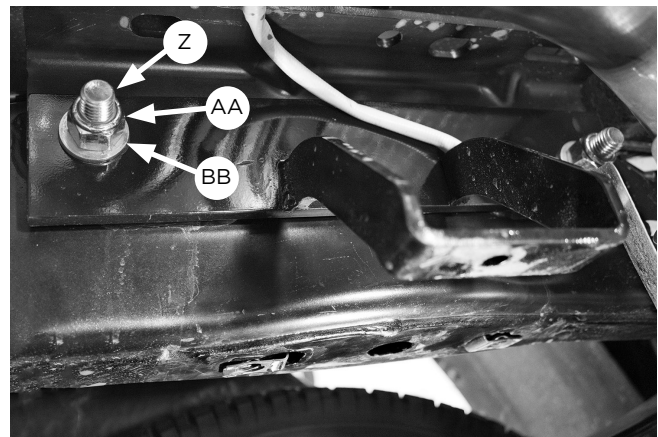

Fig. 26

Install the Air Spring Assemblies

1. With the vehicle supported by safety stands, drop the axle or raise the body so that the assemblies can be put into position in between the axle and frame. Set the driver's (left) side and passenger's (right) side assemblies into position so that the lower bracket cup nests on the jounce bumper strike plate for single rear wheel (SRW) or the axle for dual rear wheel (DRW) applications.



If you have a sway bar, insert the carriage bolts through the clamp bar (A) as you set the assemblies into position over the axle (see Fig. 30).

2. Once assemblies are in position on the jounce bumper strike plate or axle, push the lower bracket so that it is flush against the leaf spring stack and both flanges on the lower bracket are locked around the stock U-bolts (Fig. 27).

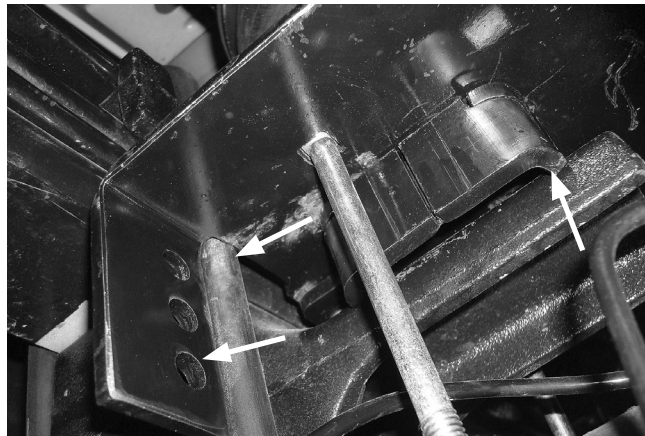

Fig. 27



The flanges need to be oriented so that they lock around the truck's existing leaf spring U-bolts. On the driver's (left) side, the long carriage bolt in the lower bracket will be between the hard brake line and axle (Fig. 33). On the passenger's (right) side, the carriage bolt will be on the back side of the brake line (Fig. 34).

3. Install the U-bolt (L) around the stock U-bolt/leaf spring assembly and insert through the topmost holes in the lower bracket main plates (Fig. 28). Cap with 3/8" flat washer (R) and 3/8" nylon lock nuts (KK). Snug bolts evenly, just enough to hold the lower bracket main plate flush against the stock U-bolts.

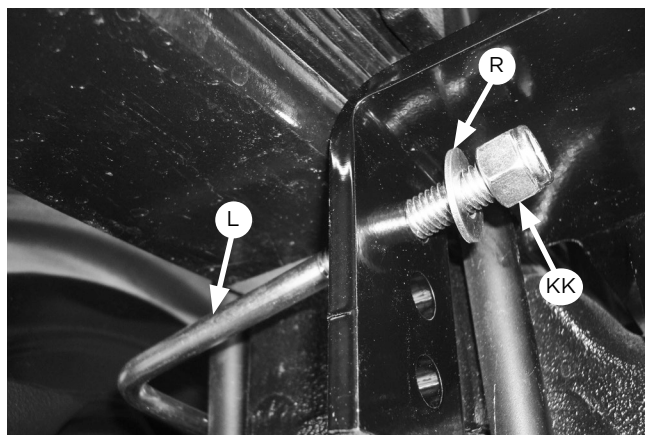

Fig. 28

4. Before proceeding, ensure the 90 degree fittings are pointing inboard toward the center of the vehicle. While raising the axle or lowering the body of the vehicle, align the previously installed upper frame bracket carriage bolts (including the one on the air spring bracket) with the air spring bracket/frame brace holes so the carriage bolts protrude. Cap all the carriage bolts with the 3/8" Serrated flange lock nuts (U) (Fig. 29). Snug the bolts down first then torque to 31 lb.-ft. (42Nm).
5. Torque the frame brace/fifth wheel 5/8" hardware supplied (Z, AA, BB if used) to 150 lb.-ft. (203Nm). If using the stock fifth wheel hardware removed, torque to 180 lb.-ft. (244Nm).
6. Torque the M10 serrated flange lock nut on the driver's (left) side brace to 37 lb.-ft. (50Nm).
7. Finish raising the axle or lowering the body and remove safety stands.
8. If not already completed (sway bar noted earlier), set the lower clamp bars (A) over the carriage bolts located under the axle (Fig. 30). Attach with 3/8" flat washers (R) and nylon lock nuts (KK). Evenly torque the lower clamp bar hardware to 16 lb.-ft. (22Nm).

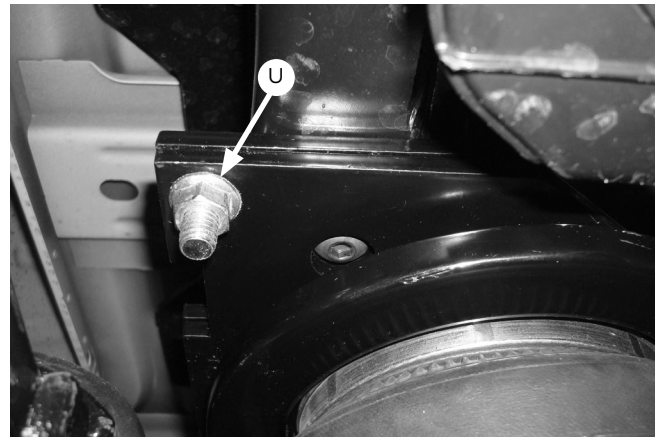

Fig. 29



For sway bar applications it is acceptable to tighten the front carriage bolt hardware down more than the rear to gain more clearance on the sway bar. Also, it may be necessary to use a 9/16" crows foot adapter to properly torque the hardware.

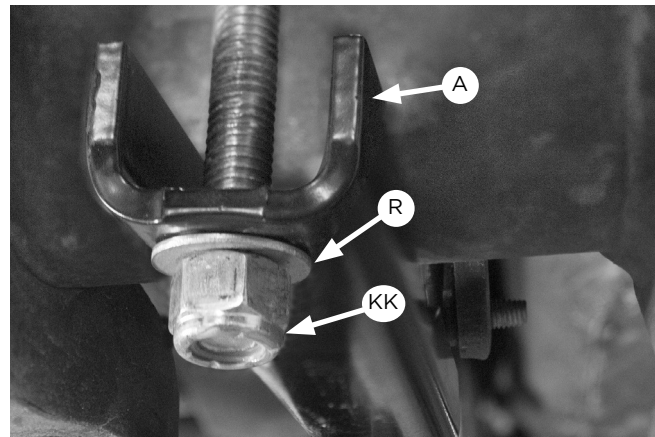
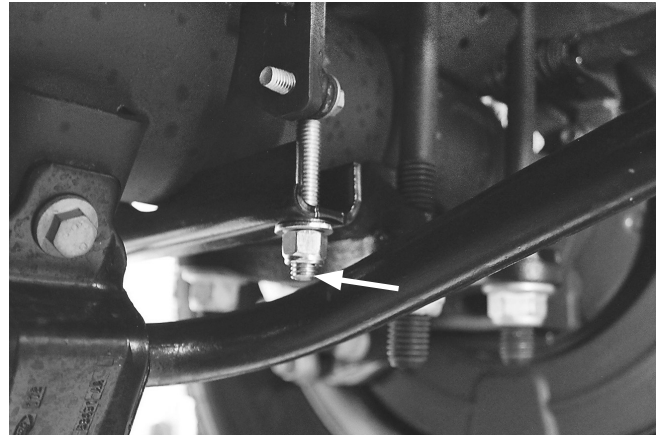

Fig. 30

9. Finish tightening the U-bolt hardware previously snugged by torquing to 10 lb.-ft. (14Nm).

10. On vehicles that have a sway bar, it will be necessary to cut the front carriage bolt just below the nut, so it does not contact the sway bar (Fig. 31).

*Fig. 31*

11. Torque the nut (Q) to 32 lb.-ft. (43Nm) on both sides (Fig. 32).

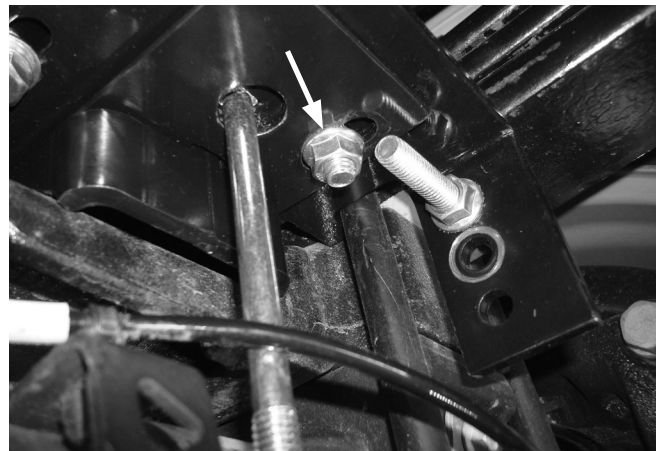
*Fig. 32*

12. Once the lower brackets are secured, make sure that the brake and ABS lines are not rubbing against the lower bracket carriage bolt. It may be necessary to pull or push the hard brake line away and tie off the ABS line to gain clearance. Note: on the passenger's (right) side, it may be necessary to pull the ABS tree mount out of the top of the bracket. Re-attach by installing the tree mount to the back hole on the bracket and tie off with a zip tie if necessary (Fig. 33 & Fig. 34).

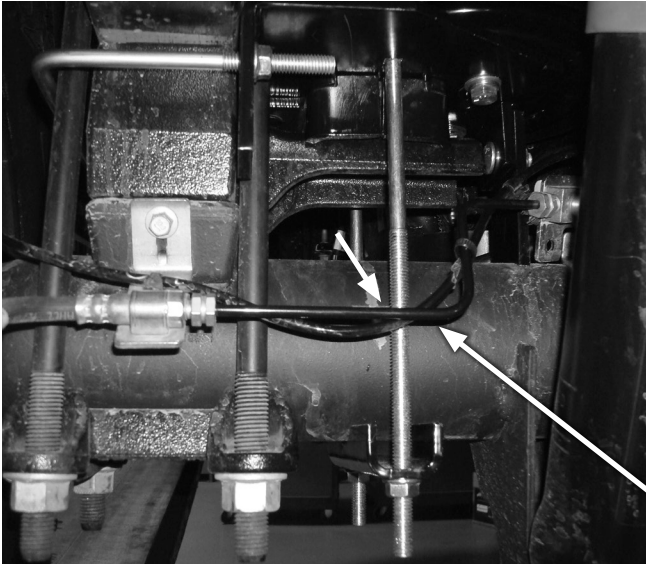

Fig. 33

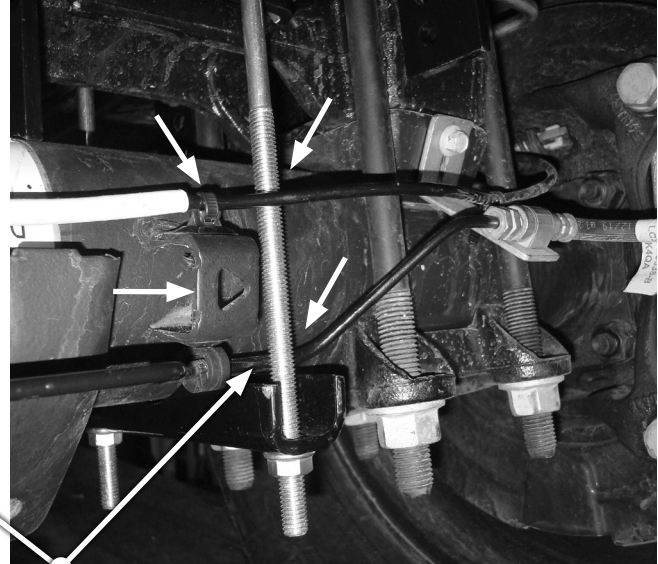

Fig. 34

If the hard brake line is resting on the lower bracket carriage bolts on either side, push or pull the brake line out of the way.

13. The axle vent tube will also have to be zip tied to one of the brake soft lines in order to keep it out of the way of the air spring assembly (Fig. 35 & Fig. 36).



Fig. 35



Fig. 36

Air Lines Installation

1. Select Schrader Valve Locations

Choose suitable locations for the Schrader valves. If necessary, drill a 5/16" (8 mm) hole at each selected location. Common locations for mounting are inside fuel tank filler door, inside rear wheel wells, or by the license plate mount or rear bumper area.

2. Measure and Cut the Air Line

Measure the length of air line needed to reach your intended Schrader valve locations. Cut the air line (AA) using a sharp razor blade or hose cutter to make clean, square cuts. Do not use scissors or wire cutters, as these can deform the tubing and compromise the seal.

3. Route and Secure the Air Line

Route the air line (AA) from each air spring to the chosen Schrader valve locations. Plan the route to avoid sharp edges, moving parts, and heat sources. Once routed, use zip ties (BB) to secure the air line to stable points along the vehicle chassis. Do not pinch or kink the line. Leave at least 2" (51 mm) of slack to accommodate movement. The air line's minimum bend radius is 1" (25 mm).



Maintain a minimum of 5 1/2" (140 mm) clearance between all air lines and any part of the exhaust system. Avoid routing air lines over sharp edges or making tight bends.

4. Install Schrader Valves

Install the Schrader valves into the selected locations.

Heat Shield Installation (if provided in kit)

1. Position the Heat Shield

Place the heat shield over the exhaust pipe near the air spring. Maintain at least 1/2" (13 mm) of clearance between the shield and the exhaust surface. Depending on the design of the heat shield included in your kit, you may need to bend the tabs or the shield itself to achieve proper fitment and spacing.

2. Install the Air Line Thermal Sleeve (if included)

If your kit includes a thermal sleeve, slide it over the section of air line that runs closest to the exhaust. This sleeve helps protect the line from excessive heat exposure.

3. Secure Components with Hose Clamps

Use hose clamps to secure the heat shield and thermal sleeve (if used). Apply double clamps where needed for added security. Make final adjustments to ensure all components are properly spaced and firmly in place.

Checklist

Ensure the air suspension system is correctly installed and safe for operation by completing the following checks:

1. Clearance Verification

Inflate the air springs to 50 PSI (3.45 BAR). Confirm a minimum clearance of 1/2" (13 mm) between the air springs and any adjacent components, including tires, brake assemblies, the vehicle frame, shock absorbers, and brake lines. Adjust as needed to prevent contact during operation.

2. Heat Clearance Check

Verify that all air springs and air lines are positioned at least 5 1/2" (140 mm) away from any heat sources.

3. Leak Inspection

With the system pressurized to 50 PSI (3.45 BAR) inspect all fittings, air lines, and connections for leaks. All leaks must be fully resolved prior to road testing.

4. Road Test Procedure

Inflate the air springs to the recommended operating pressure and conduct a 10-mile (16 km) road test. Upon completion, re-inspect for adequate clearance, air leaks, and secure fasteners.

5. Torque Confirmation

After 500 miles (800 km) of driving, recheck and torque all hardware to the specified values to ensure long-term stability and safety.

Adjusting Air Pressure

Stability

Properly adjusting air pressure is key to achieving both vehicle stability and correct ride height. Begin by increasing pressure until the suspension feels firm and controlled—without exceeding the maximum of 100 PSI (7 BAR). Ensure the vehicle sits level across all four corners. Uneven loads may require redistributing cargo or adjusting air pressure side to side.

Comfort

Ride quality is also influenced by air pressure. Too much or too little can cause harshness or instability. As a general rule:

- If the vehicle frequently bottoms out on the frame, increase air pressure.
- If the ride feels overly stiff or harsh, reduce air pressure slightly.

Adjust gradually to find the best balance between comfort and control.

Guidelines

1. Check System Pressure Weekly

Inspect the air pressure in the system at least once a week to ensure consistent performance and ride quality.

2. Maintain Proper Ride Height

Always operate the vehicle at the recommended ride height. Do not exceed 100 PSI (7.0 BAR) under any circumstances.

3. Inspect for Air Leaks as Needed

If you suspect a leak, follow these steps to identify and address the issue:

- a. Inflate the air springs to 50 PSI (3.45 BAR).
- b. Spray all air line connections and the inflation valve with a mild solution of liquid dish soap and water.
- c. Wait 30 seconds and observe for any bubbles, which indicate a leak.
- d. Recheck the system pressure after 24 hours. A pressure loss of 2–4 PSI (0.14–0.28 BAR) is normal after initial installation. If the pressure drops by more than 5 PSI (0.34 BAR), recheck for leaks.
- e. Once testing is complete, adjust the air spring to the minimum pressure required for proper ride height.

4. Inspect Hardware and Component Alignment

Periodically check that all fasteners are properly torqued. Also, check for signs of rubbing or misalignment, and realign components as needed.

5. Clean the Air Springs

Occasionally, spray the air springs with clean water to remove mud, dirt, or debris that may collect during use.

6. Lift the Vehicle with Care

If lifting the vehicle by the frame, reduce system pressure to 5 PSI (0.34 BAR) to relieve tension on the air springs and mounting hardware.

Repair Guide

Fixing Leaks on Barbed Fittings

1. Cut the air line 1 1/2" (38 mm) behind the existing fitting.
2. Use pliers or locking pliers to twist and pull the air line off the fitting.



Do not cut lengthwise, as this may damage the barbs and lead to future leaks.

3. Reinstall the air line and clamp (if applicable), making sure the air line fully covers all barbs for a proper seal.

Fixing Leaks on Push-to-Connect (PTC) Fittings

To Disconnect:

1. Release all air pressure from the system.
2. Push the air line inward toward the fitting.
3. While holding the air line in, press the collar inward toward the fitting.
4. With the collar depressed, pull the air line out.

Before Reconnecting:

5. Cut off the end of the air line just beyond the witness mark to ensure a clean, undamaged sealing surface.
6. If the fitting leaks at the threads, remove it, apply fresh thread sealant, and reinstall it 1 1/2 turns beyond finger-tight.

To Reconnect:

7. Push the air line into the fitting until fully seated.
8. Gently pull back on the air line to verify a secure connection.

Warranty

What this warranty covers

Atlas Products Company provides a warranty to the original purchaser of its Load Support Products, for the periods of time listed at AtlasProducts.com, by product line, from the date of original purchase, that the products will be free from defects in workmanship and materials when used on cars and trucks as specified by Atlas Products Company and under normal operating conditions, subject to the requirements and exclusions set forth below.

What this warranty does not cover

The warranty does not apply to products that have been improperly applied, improperly installed, or that have not been maintained in accordance with the installation instructions furnished with all products. This warranty does not apply and is void if damage or failure is caused by: accident, abuse, misuse (including but not limited to racing or off-road activities or commercial use), abnormal use, faulty installation, liquid contact, fire, earthquake or other external cause; operating the product outside Atlas Products Company's instructions, specifications or guidelines; or service, alteration, maintenance or repairs performed by anyone other than Atlas Products Company to the product from its purchased condition. This warranty also does not apply to: consumable parts, such as batteries, cosmetic damage, including but not limited to scratches or dents; defects caused by normal wear and tear or otherwise due to the normal aging of the product, or if any serial or identification number has been removed or defaced from the product. Atlas Products Company reserves the right to change the design of any product without assuming any obligation to modify any product previously manufactured.

Limitation of liability

To the extent permitted by law, this warranty and the remedies set forth herein are exclusive and in lieu of all other warranties, remedies and conditions, whether oral, written, statutory, express or implied. Atlas Products Company DISCLAIMS ALL STATUTORY AND IMPLIED WARRANTIES, INCLUDING WITHOUT LIMITATION, WARRANTIES OF MERCHANTABILITY AND FITNESS FOR A PARTICULAR PURPOSE AND WARRANTIES AGAINST HIDDEN OR LATENT DEFECTS TO THE EXTENT PERMITTED BY LAW. To the extent such warranties cannot be disclaimed, such implied warranties shall apply only for the warranty period specified above. Please note that some states do not allow limitation on how long an implied warranty (or condition) lasts. So the above limitation may not apply to you.

Except as provided in this warranty and to the extent permitted by law, Atlas Products Company shall not be liable for any direct, special, incidental or consequential damages resulting from any breach of warranty or condition, or arising in connection with the sale, use or repair of Atlas products, or under any other legal theory, including but not limited to loss of use, loss of revenue, loss of actual or anticipated profits, loss of the use of money, loss of business, loss of opportunity, loss of goodwill, and loss of reputation. Atlas Products Company's maximum liability shall not in any case exceed the purchase price paid by you for the Atlas product. Please note that some states do not allow the exclusion or limitation of incidental or consequential damages, so the above limitation or exclusion may not apply to you.

How to get service

If a defect in workmanship or materials causes your Atlas product to become inoperable within the warranty period, before returning any defective product, email Atlas Products Company at support@atlusproducts.com. The consumer shall be responsible for removing the defective product from the vehicle (including any labor charges) and returning it, shipping costs prepaid, to Atlas Products Company for verification. You must prove to the satisfaction of Atlas Products Company the date of original purchase of your Atlas product. A minimum \$10 shipping and handling charge (plus applicable sales tax) will apply to all warranty claims. You must also pack the product to minimize the risk of it being damaged in transit. If we receive a product in damaged condition as the result of shipping, we will notify you and you must seek a claim with the shipper.

What Atlas Products Company will do

If you submit a valid claim to Atlas Products Company during the warranty period, and Atlas determines that the product was defective, Atlas Products Company will, at its option, repair your Atlas product or furnish you with a new or rebuilt product. Atlas Products Company will not reimburse you for repairs or replacement parts provided by other parties. Your repaired or replacement Atlas product will be returned to you (subject to payment of the required warranty claim shipping and handling charge), and it will be covered under the warranty for the balance of the warranty period, if any. When a product or part is replaced, any replacement item becomes your property and the replaced item becomes the property of Atlas Products Company. You are responsible for the installation/reinstallation (including any labor charges) of the product.

How the law relates to this warranty

This warranty gives you specific legal rights and you may also have other rights which vary from state to state. By this warranty, Atlas Products Company does not limit or exclude your rights except as allowed by law. To fully understand your rights, you should consult the laws of your state.

Customer Support

For Customer Service support, please contact us at:
support@atlusproducts.com

Atlas Products Company reserves the right to make changes and improvements to its products and publications at any time.



Engineered and Assembled in the USA

Document No. AM-2003
Revision (012601)
ERN 10575

California:  WARNING: Cancer and Reproductive Harm - www.P65Warnings.ca.gov